

## GIGALIGHT 100GBASE QSFP28 CLR4 2KM

### Optical Transceiver Module

P/N: GQS-SPO101-CLR4

#### Preliminary Data Sheet Disclaimer

The preliminary data sheet is provided in order to finalize the product specifications. This data sheet is not applicable to products in MP. Until Gigalight releases these products for general sales, Gigalight reserves the right to change features, functions, specifications, capabilities and release schedule.

#### Features

- ◆ 4 channels full-duplex transceiver modules
- ◆ Based on 100G CLR4 MSA baseline requirement
- ◆ Transmission data rate up to 26Gbps per channel
- ◆ 4 x 26Gb/s DFB-based CWDM uncooled transmitter
- ◆ 4 channels PIN ROSA
- ◆ Internal CDR circuits on both receiver and transmitter channels
- ◆ Non airtight optical engine design
- ◆ Qualified under temperature 85°C and humidity 85% @500 hours (the variation of TX  $\leq$  2.5 dBm, RX  $\leq$  1.5 dBm)
- ◆ Low power consumption <3.5W
- ◆ Hot Pluggable QSFP form factor
- ◆ Up to reach 2km for G.652 SMF
- ◆ Duplex LC receptacles
- ◆ Built-in digital diagnostic functions
- ◆ Operating case temperature 0°C to +70°C
- ◆ 3.3V power supply voltage
- ◆ RoHS 6 compliant(lead free)

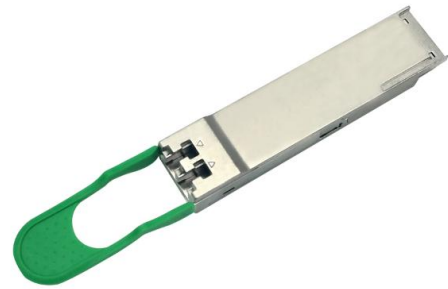

#### Applications

- ◆ Data Center Interconnect.

- ◆ 100G CLR4 applications.
- ◆ Infiniband EDR interconnects.
- ◆ Enterprise networking

## Description

This product is a 100Gb/s transceiver module designed for optical communication applications compliant with the QSFP MSA, CLR4 MSA and portions of IEEE P802.3bm standard. The module converts 4 input channels of 25Gb/s electrical data to 4 channels of CWDM optical signals and then multiplexes them into a single channel for 100Gb/s optical transmission. Reversely on the receiver side, the module de-multiplexes a 100Gb/s optical input into 4 channels of CWDM optical signals and then converts them to 4 output channels of electrical data.

The central wavelengths of the 4 CWDM channels are 1271, 1291, 1311 and 1331 nm as members of the CWDM wavelength grid defined in CLR4 MSA. The high performance Uncooled CWDM DFB transmitters and high sensitivity PIN receivers provide superior performance for 100Gigabit Ethernet applications up to 2km links .

The product is designed with form factor, optical/electrical connection and digital diagnostic interface according to the QSFP+ Multi-Source Agreement (MSA). It has been designed to meet the harshest external operating conditions including temperature, humidity and EMI interference.

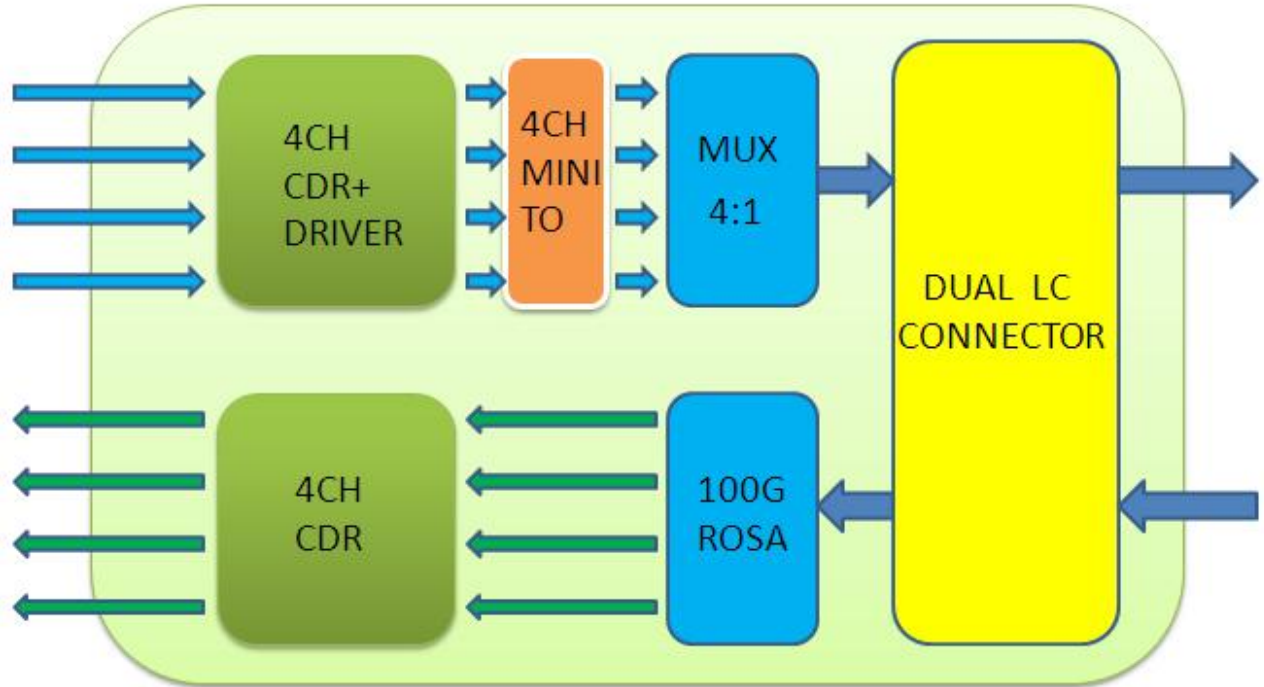

Figure1. Module Block Diagram

### Absolute Maximum Ratings

Parameter	Symbol	Min	Max	Unit
Supply Voltage	Vcc	-0.3	3.6	V
Input Voltage	Vin	-0.3	Vcc+0.3	V
Storage Temperature	Tst	-20	85	°C
Case Operating Temperature	Top	0	70	°C
Humidity(non-condensing)	Rh	5	85	%
Damage Threshold, each Lane	TH	5.5		dBm

### Recommended Operating Conditions

Parameter	Symbol	Min	Typical	Max	Unit
Supply Voltage	Vcc	3.13	3.3	3.47	V
Operating Case temperature	Tca	0		70	°C
Data Rate Per Lane	fd		25.78125		Gbps
Humidity	Rh	5		85	%
Power Dissipation	P			3.5	W
Link Distance with G.652	D	0.002		2	km

## Electrical Specifications

Parameter	Symbol	Min	Typical	Max	Unit
Power Consumption	P			3.5	W
Supply Current	I <sub>cc</sub>			1.12	A
Transceiver Power-on Initialization Time				2000	ms
Transmitter(each Lane)					
Single-ended Input Voltage Tolerance		-0.3		4.0	V
AC Common Mode Input Voltage Tolerance		15			mV
Differential Input Voltage		50			mV <sub>pp</sub>
Differential Input Voltage Swing	V <sub>in</sub>	190		1000	mV <sub>pp</sub>
Differential Input Impedance	Z <sub>in</sub>	90	100	110	Ohm
Receiver(each Lane)					
Single-ended Output Voltage		-0.3		4.0	V
AC Common Mode Output				7.5	mV
Differential Output Voltage Swing	V <sub>out</sub>	300		900	mV <sub>pp</sub>
Differential Output Impedance	Z <sub>out</sub>	90	100	110	Ohm

**Note:** Power-on Initialization Time is the time from when the power supply voltages reach and remain above the minimum recommended operating supply voltages to the time when the module is fully functional.

## Optical Characteristics

Parameter	Symbol	Min	Typical	Max	Unit	Notes
Lane Wavelength	L0	1264.5	1271	1277.5	nm	
	L1	1284.5	1291	1297.5	nm	
	L2	1304.5	1311	1317.5	nm	
	L3	1324.5	1331	1337.5	nm	
Transmitter						
SMSR	SMSR	30			dB	
Total Average Launch Power	P <sub>T</sub>			8.5	dBm	
Average Launch Power, each Lane	P <sub>AVG</sub>	-6.5		2.5	dBm	
OMA, each Lane	P <sub>OMA</sub>	-4.0		2.5	dBm	1
Launch power in OMA minus TDP		-5			dB	

TDP, each Lane	TDP			3.3	dB	
Extinction Ratio	ER	3.5			dB	
RIN <sub>20</sub> OMA	RIN			-130	dB/H	
Optical Return Loss	TOL			20	dB	
Transmitter Reflectance	R <sub>T</sub>			-20	dB	
Eye Mask coordinates: X1, X2, X3, Y1, Y2, Y3		{0.25, 0.42, 0.46, 0.28, 0.3, 0.4}				2
Average Launch Power OFF	P <sub>off</sub>			-30	dBm	
<b>Receiver</b>						
Damage Threshold, each lane	TH <sub>d</sub>	3.5			dBm	3
Average Receive Power, each lane		-10		2.5	dBm	
Receive Power (OMA), each lane				2.5	dBm	
Receiver Sensitivity (OMA), each Lane	SEN			-8.1	dBm	4
Stressed Receiver Sensitivity (OMA), each Lane				-5.6	dBm	5
Difference in receive power between any two lanes (OMA)				5.5		
Receiver Electrical 3 dB upper Cutoff Frequency, each Lane	F <sub>c</sub>			31	GHz	
<b>Conditions of Stress Receiver Sensitivity Test (Note 5)</b>						
Vertical Eye Closure Penalty	VECP	1.95			dB	6
Stressed Eye J2 Jitter	J2	0.3			UI	6
Stressed Eye J4 Jitter,	J9	0.5			UI	6

**Note:**

1. Even if the TDP < 1 dB, the OMA min must exceed the minimum value specified here.

2. Hit ratio of  $5e-5$ , per IEEE; See Figure 2 below.

---

3. The receiver shall be able to tolerate, without damage, continuous exposure to a modulated optical input signal having this power level on one lane. The receiver does not have to operate correctly at this input power.
4. Measured with conformance test signal at receiver input for BER =  $1e-12$  BER.
5. Measured with conformance test signal at TP3 for  $1e-12$ BER.
6. Vertical eye closure penalty and stressed eye jitter are test conditions for measuring stressed receiver sensitivity. They are not characteristics of the receiver.

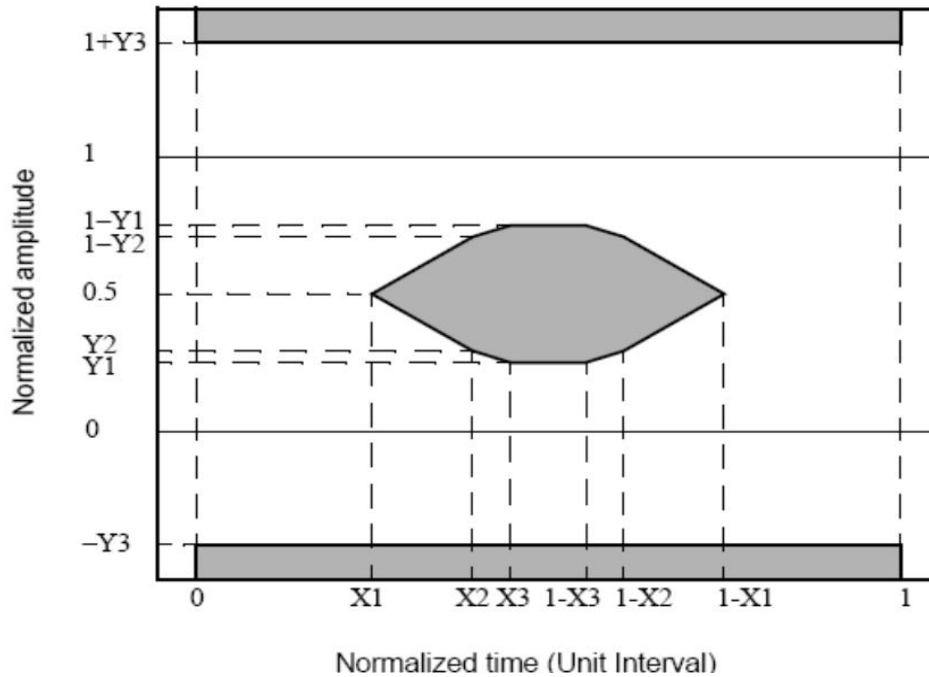

**Figure 2. Eye Mask**

## Pin Descriptions

Pin	Logic	Symbol	Name/Description	Ref.
1		GND	Module Ground	1
2	CML-I	Tx2-	Transmitter inverted data input	
3	CML-I	Tx2+	Transmitter non-inverted data input	
4		GND	Module Ground	1
5	CML-I	Tx4-	Transmitter inverted data input	
6	CML-I	Tx4+	Transmitter non-inverted data input	
7		GND	Module Ground	1
8	LVTTL-I	MODSEI	Module Select	2

		L		
9	LVTTL-I	ResetL	Module Reset	2
10		VCCR <sub>x</sub>	+3.3v Receiver Power Supply	
11	LVC MOS-I	SCL	2-wire Serial interface clock	2
12	LVC MOS-I/O	SDA	2-wire Serial interface data	2
13		GND	Module Ground	1
14	CML-O	RX3+	Receiver non-inverted data output	
15	CML-O	RX3-	Receiver inverted data output	
16		GND	Module Ground	1
17	CML-O	RX1+	Receiver non-inverted data output	
18	CML-O	RX1-	Receiver inverted data output	
19		GND	Module Ground	1
20		GND	Module Ground	1
21	CML-O	RX2-	Receiver inverted data output	
22	CML-O	RX2+	Receiver non-inverted data output	
23		GND	Module Ground	1
24	CML-O	RX4-	Receiver inverted data output	
25	CML-O	RX4+	Receiver non-inverted data output	
26		GND	Module Ground	1
27	LVTTL-O	ModPrsL	Module Present, internal pulled down to GND	
28	LVTTL-O	IntL	Interrupt output, should be pulled up on host board	2
29		VCCT <sub>x</sub>	+3.3v Transmitter Power Supply	
30		VCC1	+3.3v Power Supply	
31	LVTTL-I	LPM <sub>Mode</sub>	Low Power Mode	2
32		GND	Module Ground	1
33	CML-I	Tx3+	Transmitter non-inverted data input	
34	CML-I	Tx3-	Transmitter inverted data input	
35		GND	Module Ground	1
36	CML-I	Tx1+	Transmitter non-inverted data input	
37	CML-I	Tx1-	Transmitter inverted data input	
38		GND	Module Ground	1

**Notes:**

1. Module circuit ground is isolated from module chassis ground within the module.
2. Open collector; should be pulled up with 4.7k – 10k ohms on host board to a voltage between 3.15V and 3.6V.

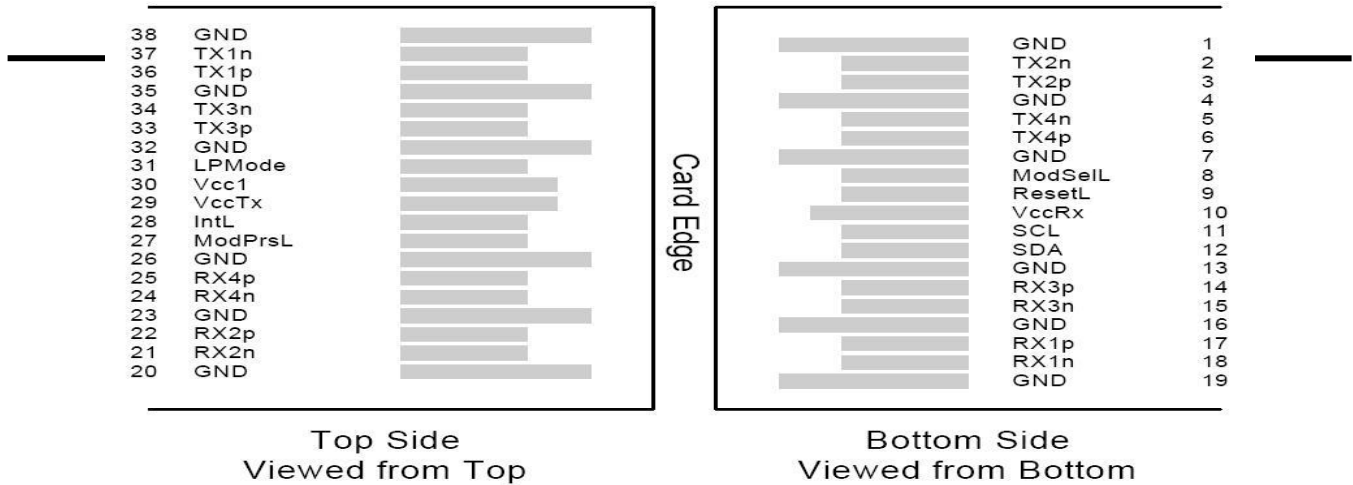

**Figure3. Electrical Pin-out Details**

### ModSelL Pin

The ModSelL is an input pin. When held low by the host, the module responds to 2-wire serial communication commands. The ModSelL allows the use of multiple QSFP modules on a single 2-wire interface bus. When the ModSelL is “High”, the module will not respond to any 2-wire interface communication from the host. ModSelL has an internal pull-up in the module.

### ResetL Pin

Reset. LPMODE\_Reset has an internal pull-up in the module. A low level on the ResetL pin for longer than the minimum pulse length ( $t_{Reset\_init}$ ) initiates a complete module reset, returning all user module settings to their default state. Module Reset Assert Time ( $t_{init}$ ) starts on the rising edge after the low level on the

ResetL pin is released. During the execution of a reset ( $t_{init}$ ) the host shall disregard all status bits until the module indicates a completion of the reset interrupt. The module indicates this by posting an IntL signal with the Data\_Not\_Ready bit negated. Note that on power up (including hot insertion) the module will post this completion of reset interrupt without requiring a reset.

### LPMODE Pin

Gigalight QSFP28 CLR4 operate in the low power mode (less than 1.5 W power consumption). This pin active high will decrease power consumption to less than 1W.

### ModPrsL Pin

ModPrsL is pulled up to Vcc on the host board and grounded in the module. The ModPrsL is asserted



“Low” when the module is inserted and deasserted “High” when the module is physically absent from the host connector.

### IntL Pin

IntL is an output pin. When “Low”, it indicates a possible module operational fault or a status critical to the host system. The host identifies the source of the interrupt by using the 2-wire serial interface. The IntL pin is an open collector output and must be pulled up to Vcc on the host board.

### Power Supply Filtering

The host board should use the power supply filtering shown in Figure 4.

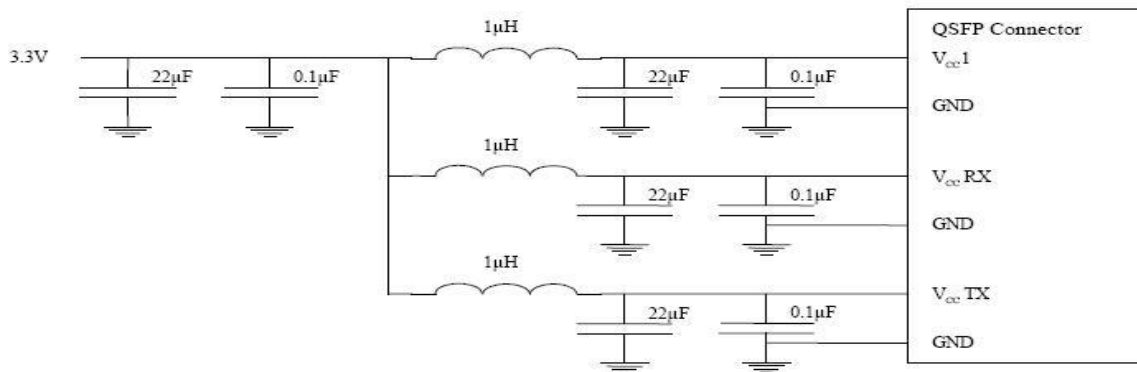

Figure 4. Host Board Power Supply Filtering

### DIAGNOSTIC MONITORING INTERFACE

Parameter	Symbol	Min	Max	Units	Notes
Temperature monitor absolute error	DMI_Temp	-3	+3	degC	Over operating temperature range
Supply voltage monitor absolute error	DMI_VCC	-0.1	0.1	V	Over full operating range
Channel RX power monitor absolute error	DMI_RX_Ch	-2	2	dB	1
Channel Bias current monitor	DMI_Ibias_Ch	-10%	10%	mA	
Channel TX power monitor absolute error	DMI_TX_Ch	-2	2	dB	1

The following digital diagnostic characteristics are defined over the normal operating conditions unless otherwise specified.

#### Notes:

1, Due to measurement accuracy of different single mode fibers, there could be an additional  $\pm 1$ dB

fluctuation, or a  $\pm 3$  dB total accuracy.

---

Digital diagnostics monitoring function is available on all Gigalight QSFP28 CLR4. A 2-wire serial interface provides user to contact with module.

The structure of the memory is shown in Figure 5. The memory space is arranged into a lower, single page, address space of 128 bytes and multiple upper address space pages. This structure permits timely access to addresses in the lower page, such as Interrupt Flags and Monitors. Less time critical time entries, such as serial ID information and threshold settings, are available with the Page Select function. The interface address used is A0xh and is mainly used for time critical data like interrupt handling in order to enable a one-time-read for all data related to an interrupt situation. After an interrupt, IntL, has been asserted, the host can read out the flag field to determine the affected channel and type of flag.

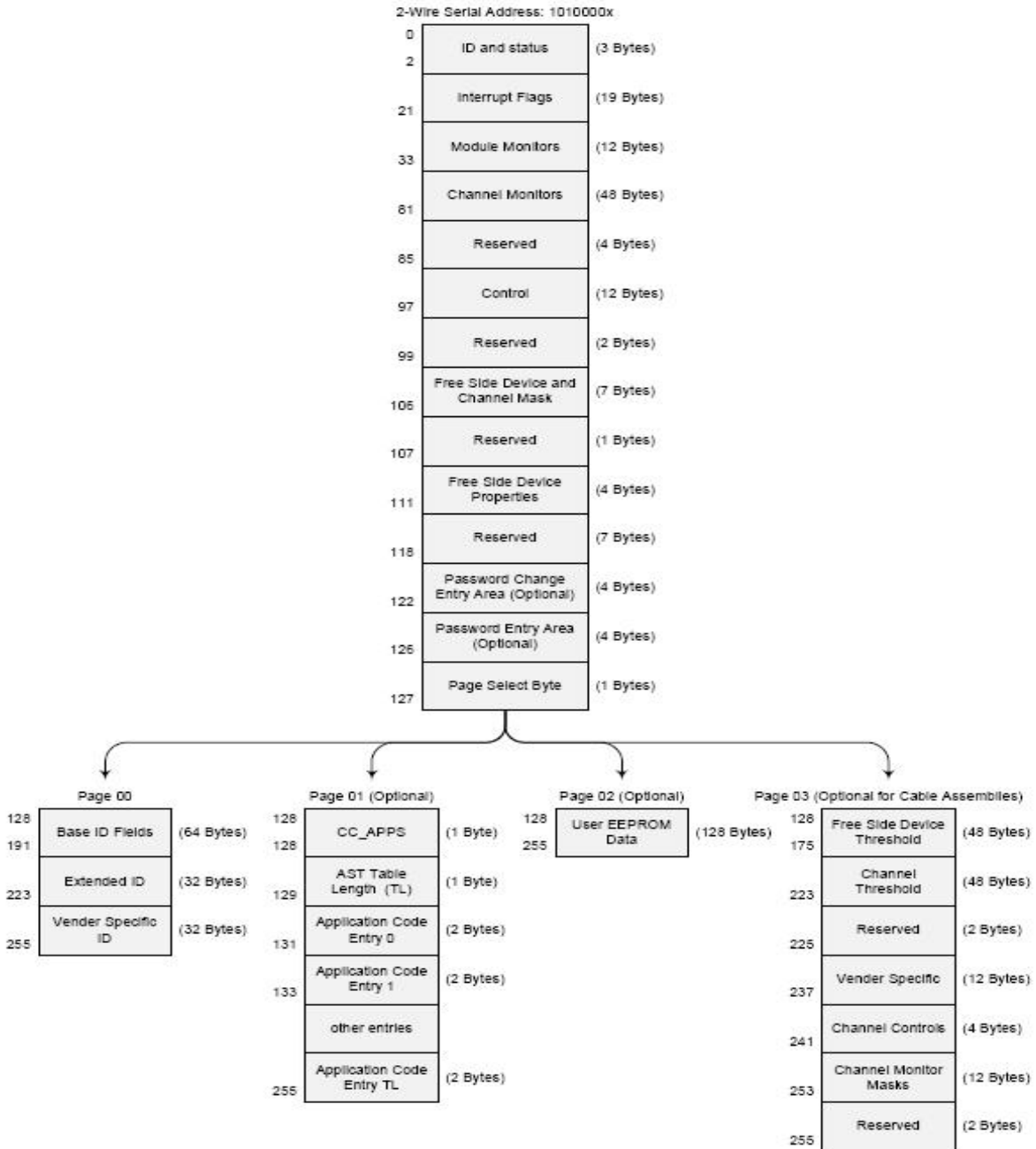

Figure5. QSF Memory Map

Byte Address	Description	Type
0	Identifier (1 Byte)	Read Only
1-2	Status (2 Bytes)	Read Only
3-21	Interrupt Flags (31 Bytes)	Read Only
22-33	Module Monitors (12 Bytes)	Read Only
34-81	Channel Monitors (48 Bytes)	Read Only
82-85	Reserved (4 Bytes)	Read Only
86-97	Control (12 Bytes)	Read/Write
98-99	Reserved (2 Bytes)	Read/Write
100-106	Module and Channel Masks (7 Bytes)	Read/Write
107-118	Reserved (12 Bytes)	Read/Write
119-122	Reserved (4 Bytes)	Read/Write
123-126	Reserved (4 Bytes)	Read/Write
127	Page Select Byte	Read/Write

**Figure 6. Low Memory Map**

Byte Address	Description	Type
128-175	Module Thresholds (48 Bytes)	Read Only
176-223	Reserved (48 Bytes)	Read Only
224-225	Reserved (2 Bytes)	Read Only
226-239	Reserved (14 Bytes)	Read/Write
240-241	Channel Controls (2 Bytes)	Read/Write
242-253	Reserved (12 Bytes)	Read/Write
254-255	Reserved (2 Bytes)	Read/Write

**Figure 7. Page 03 Memory Map**

Address	Name	Description
128	Identifier (1 Byte)	Identifier Type of serial transceiver
129	Ext. Identifier (1 Byte)	Extended identifier of serial transceiver
130	Connector (1 Byte)	Code for connector type
131-138	Transceiver (8 Bytes)	Code for electronic compatibility or optical compatibility
139	Encoding (1 Byte)	Code for serial encoding algorithm
140	BR, nominal (1 Byte)	Nominal bit rate, units of 100 Mbits/s
141	Extended RateSelect Compliance (1 Byte)	Tags for Extended RateSelect compliance
142	Length SMF (1 Byte)	Link length supported for SM fiber in km
143	Length E-50 $\mu\text{m}$ (1 Byte)	Link length supported for EBW 50/125 $\mu\text{m}$ fiber, units of 2 m
144	Length 50 $\mu\text{m}$ (1 Byte)	Link length supported for 50/125 $\mu\text{m}$ fiber, units of 1 m
145	Length 62.5 $\mu\text{m}$ (1 Byte)	Link length supported for 62.5/125 $\mu\text{m}$ fiber, units of 1 m
146	Length copper (1 Byte)	Link length supported for copper, units of 1 m
147	Device Tech (1 Byte)	Device technology
148-163	Vendor name (16 Bytes)	QSFP vendor name (ASCII)
164	Extended Transceiver (1 Byte)	Extended Transceiver Codes for InfiniBand <sup>†</sup>
165-167	Vendor OUI (3 Bytes)	QSFP vendor IEEE vendor company ID
168-183	Vendor PN (16 Bytes)	Part number provided by QSFP vendor (ASCII)
184-185	Vendor rev (2 Bytes)	Revision level for part number provided by vendor (ASCII)
186-187	Wavelength (2 Bytes)	Nominal laser wavelength (Wavelength = value / 20 in nm)
188-189	Wavelength Tolerance (2 Bytes)	Guaranteed range of laser wavelength (+/- value) from Nominal wavelength (Wavelength Tol. = value / 200 in nm)
190	Max Case Temp (1 Byte)	Maximum Case Temperature in Degrees C
191	CC_BASE (1 Byte)	Check code for Base ID fields (addresses 128-190)
192-195	Options (4 Bytes)	Rate Select, TX Disable, TX Fault, LOS
196-211	Vendor SN (16 Bytes)	Serial number provided by vendor (ASCII)
212-219	Date code (8 Bytes)	Vendor's manufacturing date code
220	Diagnostic Monitoring Type (1 Byte)	Indicates which type of diagnostic monitoring is implemented
221	Enhanced Options (1 Byte)	Indicates which optional enhanced features are implemented
222	Reserved (1 Byte)	Reserved
223	CC_EXT	Check code for the Extended ID Fields (addresses 192-222)
224-255	Vendor Specific (32 Bytes)	Vendor Specific EEPROM

**Figure 8. Page 00 Memory Map**

Page02 is User EEPROM and its format decided by user. The detail description of low memory and page00.page03 upper memory please see SFF-8436 and SFF-8636 document.

## SFF-8636 Specification

### TX AND RX CDR LOL indicator (Byte 5)

Bit	Field Name	Description	Bit 7	Bit 6	Bit 5	Bit 4
5	L-Tx4 LOL	Latched TX CDR LOL indicator, ch 4	0	0	0	0
	L-Tx3 LOL	Latched TX CDR LOL indicator, ch 3	0	0	0	0
	L-Tx2 LOL	Latched TX CDR LOL indicator, ch 2	0	0	0	0
	L-Tx1 LOL	Latched TX CDR LOL indicator, ch 1	0	0	0	0
	L-Rx4 LOL	Latched RX CDR LOL indicator, ch 4	0	0	0	0
	L-Rx3 LOL	Latched RX CDR LOL indicator, ch 3	0	0	0	0
	L-Rx2 LOL	Latched RX CDR LOL indicator, ch 2	0	0	0	0
	L-Rx1 LOL	Latched RX CDR LOL indicator, ch 1	0	0	0	0

### TX AND RX CDR BYPASS CONTROL (Byte 98)

Bit	Field Name	Description	Bit 7	Bit 6	Bit 5	Bit 4
98	Tx4_CDR_control	Channel 4 TX CDR Control (1b = CDR on, 0b = CDR off)	0	0	0	0
	Tx3_CDR_control	Channel 3 TX CDR Control (1b = CDR on, 0b = CDR off)	0	0	0	0
	Tx2_CDR_control	Channel 2 TX CDR Control (1b = CDR on, 0b = CDR off)	0	0	0	0
	Tx1_CDR_control	Channel 1 TX CDR Control (1b = CDR on, 0b = CDR off)	0	0	0	0
	Rx4_CDR_control	Channel 4 RX CDR Control (1b = CDR on, 0b = CDR off)	0	0	0	0
	Rx3_CDR_control	Channel 3 RX CDR Control (1b = CDR on, 0b = CDR off)	0	0	0	0
	Rx2_CDR_control	Channel 2 RX CDR Control (1b = CDR on, 0b = CDR off)	0	0	0	0
	Rx1_CDR_control	Channel 1 RX CDR Control (1b = CDR on, 0b = CDR off)	0	0	0	0



**TABLE 6-33 OUTPUT DIFFERENTIAL AMPLITUDE CONTROL (PAGE 03H BYTES 238-239)**

Value	Receiver Output Amplitude No Output Equalization	
	Nominal	Units
1xxb	Reserved	
0111b	Reserved	mV(P-P)
0110b	Reserved	mV(P-P)
0101b	Reserved	mV(P-P)
0100b	Reserved	mV(P-P)
0011b	600-1200	mV(P-P)
0010b	400-800	mV(P-P)
0001b	300-600	mV(P-P)
0000b	100-400	mV(P-P)

**TABLE 6-34 INPUT EQUALIZATION (PAGE 03H BYTES 234-235)**

Value	Transmitter Input Equalization	
	Nominal	Units
11xxb	Reserved	
1011b	Reserved	
1010b	10	dB
1001b	9	dB
1000b	8	dB
0111b	7	dB
0110b	6	dB
0101b	5	dB
0100b	4	dB
0011b	3	dB
0010b	2	dB
0001b	1	dB
0000b	0	No EQ

**TABLE 6-35 OUTPUT EMPHASIS CONTROL (PAGE 03H BYTES 236-237)**

Value	Receiver Output Emphasis At nominal Output Amplitude	
	Nominal	Units
1xxx <sub>b</sub>	Reserved	
0111 <sub>b</sub>	7	dB
0110 <sub>b</sub>	6	dB
0101 <sub>b</sub>	5	dB
0100 <sub>b</sub>	4	dB
0011 <sub>b</sub>	3	dB
0010 <sub>b</sub>	2	dB
0001 <sub>b</sub>	1	dB
0000 <sub>b</sub>	0	No Emphasis

### Timing for Soft Control and Status Functions

Parameter	Symbol	Max	Unit	Conditions
Initialization Time	t_init	2000	ms	Time from power on <sup>1</sup> , hot plug or rising edge of Reset until the module is fully functional <sup>2</sup>
Reset Init Assert Time	t_reset_init	2	μs	A Reset is generated by a low level longer than the minimum reset pulse time present on the ResetL pin.
Serial Bus Hardware Ready Time	t_serial	2000	ms	Time from power on <sup>1</sup> until module responds to data transmission over the 2-wire serial bus
Monitor Data Ready Time	t_data	2000	ms	Time from power on <sup>1</sup> to data not ready, bit 0 of Byte 2, deasserted and IntL asserted
Reset Assert Time	t_reset	2000	ms	Time from rising edge on the ResetL pin until the module is fully functional <sup>2</sup>
LPMODE Assert Time	ton_LPMODE	100	μs	Time from assertion of LPMODE (Vin:LPMODE = Vih) until module power consumption enters lower Power Level
IntL Assert Time	ton_IntL	200	ms	Time from occurrence of condition triggering IntL until Vout:IntL = Vol
IntL Deassert Time	toff_IntL	500	μs	Time from clear on read <sup>3</sup> operation of associated flag until Vout:IntL = Voh. This includes deassert times for Rx LOS, Tx Fault and other flag bits.
Rx LOS Assert Time	ton_los	100	ms	Time from Rx LOS state to Rx LOS bit set and IntL asserted
Tx Fault Assert Time	ton_Txfault	200	ms	Time from Tx Fault state to Tx Fault bit set and IntL asserted
Flag Assert Time	ton_flag	200	ms	Time from occurrence of condition triggering flag to associated flag bit set and IntL asserted



Mask Assert Time	ton_mask	100	ms	Time from mask bit set <sup>4</sup> until associated IntL assertion is inhibited
Mask Deassert Time	toff_mask	100	ms	Time from mask bit cleared <sup>4</sup> until associated IntL operation resumes
ModSelL Assert Time	ton_ModSelL	100	μs	Time from assertion of ModSelL until module responds to data transmission over the 2-wire serial bus
ModSelL Deassert Time	toff_ModSelL	100	μs	Time from deassertion of ModSelL until the module does not respond to data transmission over the 2-wire serial bus
Power_over-ride or Power-set Assert Time	ton_Pdown	100	ms	Time from P_Down bit set <sup>4</sup> until module power consumption enters lower Power Level
Power_over-ride or Power-set Deassert Time	toff_Pdown	300	ms	Time from P_Down bit cleared <sup>4</sup> until the module is fully functional <sup>3</sup>

**Note:**

1. Power on is defined as the instant when supply voltages reach and remain at or above the minimum specified value.
2. Fully functional is defined as IntL asserted due to data not ready bit, bit 0 byte 2 deasserted.
3. Measured from falling clock edge after stop bit of read transaction.
4. Measured from falling clock edge after stop bit of write transaction.

**Mechanical Dimensions**

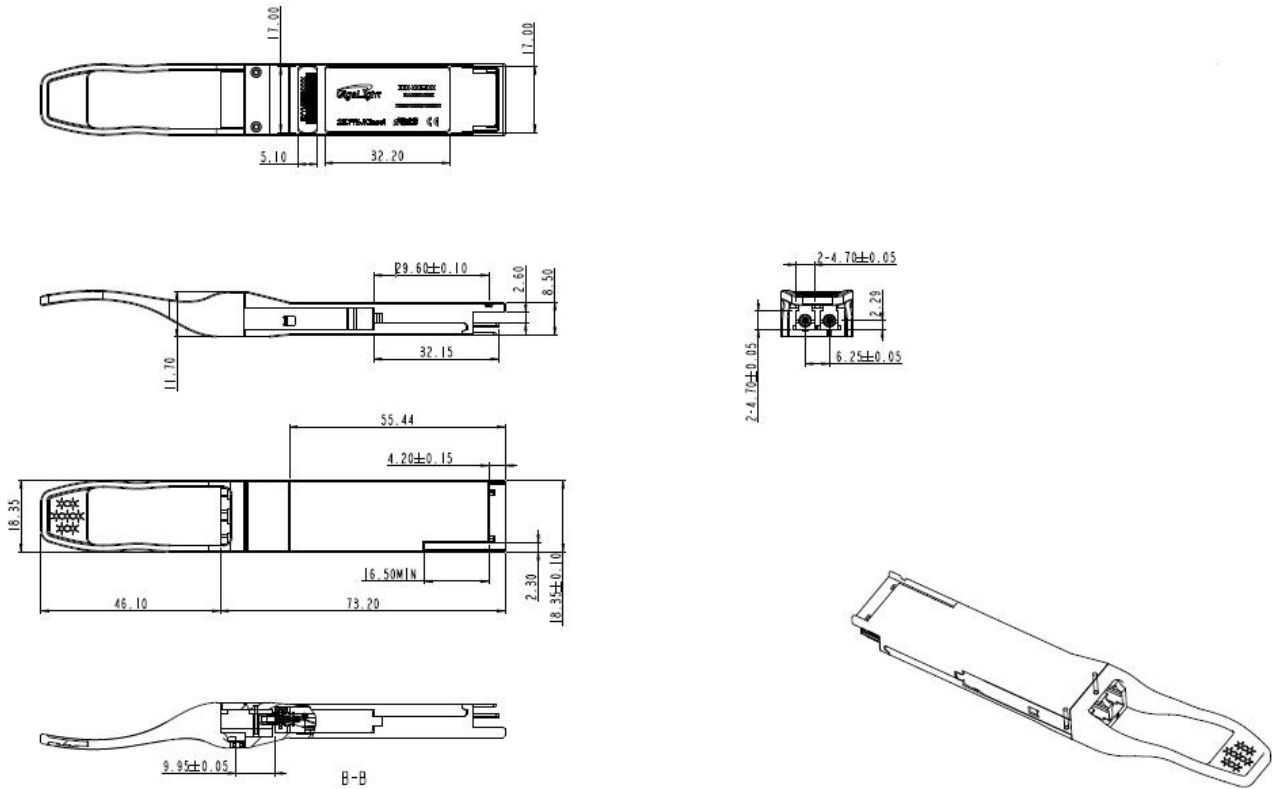

Figure 9 . Mechanical Specifications (unit: mm)

### Ordering information

Part Number	Product Description
GQS-SPO101-CLR4	100GE, QSFP28, 100GBASE CLR4 2km

### References

1. SFF-8436.
2. SFF-8636.
3. SFF-8431.
4. SFF-8665.
5. 100G CLR4 MSA.
6. IEEE 802.3bm.
7. IEEE 802.3ba.

### ESD

This transceiver is specified as ESD threshold 1kV for SFI pins and 2kV for all other electrical input pins, tested per MIL-STD-883, Method 3015.4 /JESD22-A114-A (HBM). However, normal ESD

precautions are still required during the handling of this module. This transceiver is shipped in ESD protective packaging. It should be removed from the packaging and handled only in an ESD protected environment.

## Laser Safety

This is a Class 1 Laser Product according to IEC 60825-1:2007. This product complies with 21 CFR 1040.10 and 1040.11 except for deviations pursuant to Laser Notice No. 50, dated (June 24, 2007).

## Important Notice

Performance figures, data and any illustrative material provided in this data sheet are typical and must be specifically confirmed in writing by GIGALIGHT before they become applicable to any particular order or contract. In accordance with the GIGALIGHT policy of continuous improvement specifications may change without notice.

The publication of information in this data sheet does not imply freedom from patent or other protective rights of GIGALIGHT or others. Further details are available from any GIGALIGHT sales representative.

### CAUTION:

Use of controls or adjustment or performance of procedures other than those specified herein may result in hazardous radiation exposure

Email: [sales@gigalight.com](mailto:sales@gigalight.com)

<http://www.gigalight.com>

## Revision History

Revision	Level	Date	Description
V0	Preliminary	OCT-17- 2018	Advance Release.