

VM-Series

J1939 multiplexed
operator control module

PRODUCT WEBPAGE

request sample, watch video



The VM-Series incorporates the Contura® switches actuator style flexibility with SAEJ1939 CAN Bus technology to create a multiplexed operator control module. Additionally, the VM-Series increases product reliability, while reducing the complexity of wire harnesses and improving assembly efficiencies.

12/24
VDC

250,000
Operations

IP68 Sealing
Above and below panel

Typical Applications

- Commercial Vehicles
- Construction Equipment
- Agricultural Equipment
- Work Trucks

Design Features

IP68 SEALING PROTECTION

Fully sealed above panel and below panel (when connected)

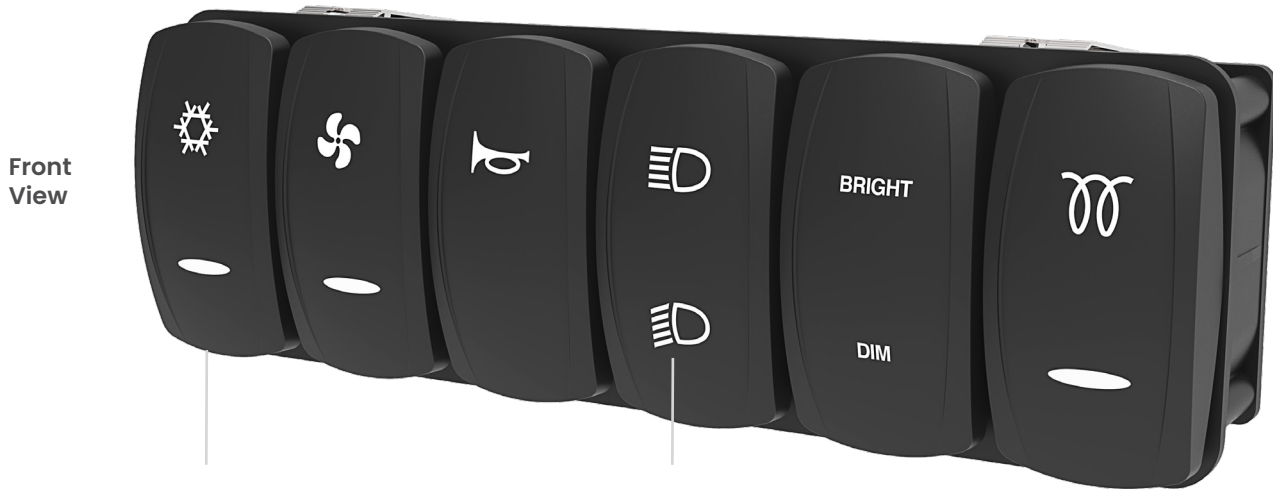

Front View

ROCKERS

Variety of removable V-Series Contura® actuator styles

CUSTOMIZABLE ICONS

Choose from our extensive library of legends, or customize your own.

Back View

VM6



6 PIN CONNECTOR

Mates to the Deutsch DT-Series Connector.

SNAP-IN MOUNTING

For fast, easy assembly.

VM3

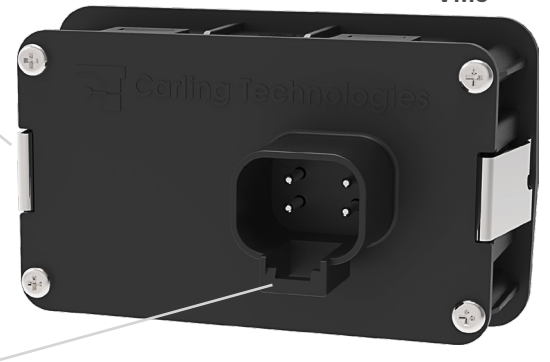

4 PIN CONNECTOR

Mates to the Deutsch DT-Series Connector. Can be used to Daisy-chain multiple VM-Series.

Related Products



CLTM12-S-Series >
Load Controller



CKJ-Series >
Jog Switch



CKP-Series >
Customizable Keypad

Tech Specs

Electrical

		VM3	VM6
Operating Voltage		12 or 24VDC systems	
Maximum Current		Operation: 250mA Sleep mode: 6mA	Operation: 300mA Sleep mode: 3mA
Electrical Endurance		Minimum 250,000 operations (50,000 cycles at -40°C, 150,000 cycles at room temperature, and 50,000 cycles at 85°C) with Contura V+ rocker style	
Over Voltage	ISO 16750-2	Apply voltage 36VDC for 60 min at 65°C	
Short Circuit Protection	ISO 16750-2	All signal inputs and outputs short to ground for 60s	
Reverse Polarity Protection	ISO 16750-2	12 VDC systems: -24VDC for 5 minutes 24 VDC systems: -36VDC for 5 minutes	
Starting Profile	ISO 16750-2	Class A	
Withstand Voltage	ISO 16750-2	500Vrms (50 Hz to 60 Hz) with a duration of 60s	
Insulation Resistance	ISO 16750-2	Minimum 10 Mohms at 500 VDC with a duration of 60s	
Superimposed Alternating Voltage	ISO 16750-2	Severity 2, Upp of 4V for Un=12V and Un=24V	
Slow Decrease and Increase of Supply Voltage	ISO 16750-2	Power supply from 8V to 0V, 0V to 8V, rate of 0.5 ± 0.1) V/min linear	
Momentary Drop in Supply Voltage	ISO 16750-2	Voltage drop from 8V to 4.5V for 12V system, 16V to 9V for 24V system. Dwell 10ms.	

Electromagnetic Compatibility (EMC)

		VM3	VM6
ESD	ISO 10605	±15kV air discharges, ±8kV contact discharges	
Absorbed-Lined Chamber	ISO 11452-2	100V/m, 80MHz to 2GHz	100V/m, 20MHz to 2GHz
Bulk Current Injection	ISO 11452-4	100mA, 20MHz to 400MHz	
Conducted Transients	ISO 7637-2	Applied level IV according to ISO 7637, Annex A, and ISO 16750-2, sections 4.6.3 & 4.6.4	All test pulses according to ISO 7637, Annex table A2 for 24V systems, level 3 minimum
Transient Emissions	ISO 13766	Annex D and E, 30MHz to 1GHz	

Environmental

		VM3	VM6
Operating Temperature		-40 °C to + 85°C	
Storage Temperature		-40°C to + 85°C	
Thermal, Hot Soak	IEC 60068-2-2	Test Bb, 85°C for 96 hours	
Thermal, Cold Soak	IEC 60068-2-1	Test Ad, -40°C for 96 hours	
Thermal Shock	IEC 60068-2-14	Test Na, -40°C to 85°C, 1 hour per cycle (30 minutes at -40°C, 30 minutes at 85°C) 10 cycles	
Thermal Cycling	IEC 60068-2-14	Test Nb, -40°C to 85°C, 2 cycles of 8 hours each	
Sealing Protection	IEC 60529	IP68, for above and below panel components of actual switch only (when connected), 1.2m deep water for 60 ± 2 min	
Solar Radiation	IEC 60068-2-5	Procedure B, 40°C for 10 days	
Humidity, Soak	IEC 60068-2-78	Test Cab, 30°C at 93% RH for 10 days	
Humidity, Cyclic	IEC 60068-2-30	Test Db, Method 1, 55°C to 25°C at >90% R.H., 6 cycles of 24 hours each	
Salt Spray	IEC 60068-52	Test Kb, severity level 4	
Chemical Resistance	ISO 16750-5	Method II for engine oil, hydraulic oil, diesel fuel, grease, and urea at max temperature	

Tech Specs

Mechanical

		VM3	VM6
Vibration, Random	IEC 60068-2-64	Test Fh, method 1, random excitation at 10, 150, 220 and 350 Hz breakpoint frequencies, 5 hours in each axis	
Vibration, Resonance	IEC 60068-2-6	Sinusoidal from 10-2000 Hz, 5 minutes at resonant points	
Vibration, General	IEC 60068-2-6	Swept sine wave from 5 to 500 Hz, ± 15mm amplitude, 5g, 20 cycles in each plane	
Shock	IEC 60068-2-27	3 shocks in each direction of the 3 axes (18 total shocks) at 500 m/s ² for 11 ms	
Bump	IEC 60068-2-27	100 shocks in each direction of the 3 axes (600 total shocks) at 400 m/s ² for 6 ms	
Drop Test	IEC 60068-2-31	Test Ec, free fall procedure 1, drop in each direction of the 3 axes (6 total drops) from 500mm	

Physical

		VM3	VM6
Switch Functions		2 Position Maintained 2 Position Momentary Top 2 Position Momentary Bottom 3 Position Momentary Bottom 3 Position Maintained 3 Position Momentary Top and Bottom 3 Position Momentary Top	
Illumination		Single color LED (Red, Green, Amber, Blue, White) (See Table A)	
Soft Lock		Yes	
Mounting		Front panel, removable from a side	
Depth Behind Panel		Depth behind panel 41mm [1.6 in]	
Weight		~91 grams [0.2 lb]	~227 grams [0.5 lb]
Materials		Housing – Acetal, UV stabilized; Back cover – Acetal, UV stabilized; Rocker – Polycarbonate / Nylon; Mounting clips – Stainless Steel	
RoHS		Yes	
REACH		Yes	
Connector		Deutsch DT-Series 4 and 6 pin (6 pin for VM6 only)	

Software

		VM3	VM6
Communication		Master: CAN 2.0b (SAE J1939)	
Programming		During manufacture or via CAN	
Sleep Mode		Any switch can be configured to wake the unit, which also activates the switch function.	
Dimming		LED dimming controlled by ECU through CAN bus	

Tech Specs

Software Interface Integration

Click below on integrating the VM-Series into J1939 CAN network:
www.carlingtech.com/sites/default/files/documents/vm-series_interface.pdf

Tables

Table A: Illumination Table (for each switch position)

Location	Type	Color	Option
Top LED	Backlight	Red, Green, Amber, Blue or White	Continuous Flashing
	Function	Red, Green, Amber, Blue or White	ON with Switch, ON with Device
Bottom LED	Backlight	Red, Green, Amber, Blue or White	Continuous Flashing
	Function	Red, Green, Amber, Blue or White	ON with Switch, ON with Device

Table B: Connector 1 Pinout for VM3

	Pin	1	2	3	4
Option 1	Signal	VCC	GND	CAN_H	CAN_L

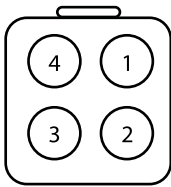

Figure 1:
Connector 1 Pinout

Table C: Connector 1 Pinout for VM6

	Pin	1	2	3	4
Option 1	Signal	VCC	GND	CAN_H	CAN_L
Option 2	Signal	Out 1	Out 2	Out 3	Out 4

Note: Out 1 to Out 4 is to control loads with max output current 0.5A @ 24VDC

Table B: Connector 1 Pinout for VM6

	Pin	1	2	3	4	5	6
Option 1	Signal	CAN_L	CAN_H	NC	NC	GND	VCC

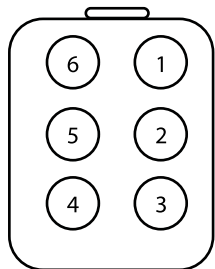

Figure 2:
Connector 2 Pinout

Ordering Scheme

Part 1: Module and Rocker Style

Sample Part No. **VM 6 - 1 F 1**

Selection 1 2 3 4 5

1. SERIES

VM V-Series Module System

2. SIZE

3 3 Position
6 6 Position

3. COMMUNICATION PROTOCOL

1 J1939
3 J1939 with Control Relay (available with 6 position size only)

4. ROCKER STYLE

A Contura II	H Contura VII
B Contura III	J Contura X
C Contura IV	K Contura XI
D Contura IV - Laser Etched	L Contura XII
E Contura V	M Contura XIV
F Contura V - Laser Etched	N Contura XIV - Laser Etched
G Contura VI	Z No Rockers

5. ORIENTATION See orientation diagram page for more details

1 Orientation 1
2 Orientation 2
3 Orientation 3
4 Orientation 4

Part 2: Module Circuit and Lamps

Switch 1 to 3 VM3 and VM6 **1 B 2 A - 2 A 1 0 - 6 0 0 0 -**

Selection 1 2 3 4 1 2 3 4 1 2 3 4

Switch 4 to 6 VM6 Only **1 B 2 A - 2 A 1 0 - 6 0 0 0**

Selection 1 2 3 4 1 2 3 4 1 2 3 4

1. CIRCUIT

1 2 Position Maintained
2 2 Position Momentary Top
3 2 Position Momentary Bottom
4 3 Position Momentary Bottom
5 3 Position Maintained
6 3 Position Momentary Top and Bottom
7 3 Position Momentary Top

2. LAMP CIRCUIT

A L1 Backlight
B L1, L2 Backlight
C L2 Backlight
D L1 Backlight, L2 Function Light
E L1, L2 Function Light
F L1 Function Light, L2 Backlight
G L1 Function Light
H L2 Function Light
O No Lamp

3. LAMP 1

1 LED 1, Red
2 LED 1, Green
3 LED 1, Blue
4 LED 1, Amber
5 LED 1, White
O No LED

4. LAMP 2

A LED 2, Red
B LED 2, Green
C LED 2, Blue
D LED 2, Amber
G LED 2, White
O No LED

Continue to next page for Ordering Scheme Part 3

Ordering Scheme

Part 3: Rockers

All Rocker options must match box 4 from part 1. For additional options, consult factory.

Contura II, III, IV, V, VII and XIV Rockers

Sample Part No. VV A Z C 00 - 0 00

Selection 1 2 3 4 5 6 7

1. SERIES

VV V-Series Rocker

2. ACTUATOR STYLE

Contura II
A Thick end over terminals 1-4
B Thick end over terminals 3-6

Contura III
C Thick end over terminals 1-4
D Thick end over terminals 3-6

Contura IV
E Left brow, lens
T Left brow, laser-etched
F Right brow, lens
R Right brow, laser-etched

Contura V
G Contura V
P Laser-Etched

Contura VII
Z Contura VII

Contura XIV
FA Contura XIV
FB Laser-Etched

3. LENS

Z - No Lens		Lens Color				Lens Style Location				
Clear	White	Amber	Green	Red	Blue	II	III	IV	V	XIV
1	6	8	G	M	T					
2	7	C	H	N	U					
3	8	D	J	P	V					
4	9	E	K	R	W		N/A			
5	A	F	L	S	Y		N/A			
5	A	N/A	N/A	N/A	N/A	XIV laser-etched only				

Only **Contura VII**

Z - No Lens		Lens Color				Lens Style Location				
White	Amber	Green	Red	Blue						
6	B	G	M	T						
7	C	H	N	U						
8	D	J	P	V						
9	E	K	R	W						
A	F	L	S	Y						
1	2	3	4	5						

Lens color for LEDs must be clear, white, or match color of LED.

4. ACTUATOR COLOR AND TEXTURE

Contura II & III
B Black **G** Gray **R** Red **W** White (Soft Surface)
C Black **H** Gray **S** Red **Y** White (Hard Surface)

Contura IV & V
C Black **H** Gray **S** Red **Y** White
Laser-Etched only **D** Nickel **E** Pewter

Contura VII
C Black **H** Gray **S** Red **Y** White

Contura XIV
C Black **S** Red **Y** White

5. ACTUATOR LENS OR BODY LEGENDS

11 ON	12 OFF	13	14 O	
OFF	ON	O	I	
15 O O	16 O O	17 O I	18 I O	
F N	N F			
F	F			

See standard legends codes page. Consult factory for additional icons.

6. LEGEND ORIENTATION

0 No legend (used with codes 11-18 in box 5)
1 Orientation 1
2 Orientation 2
3 Orientation 3
4 Orientation 4

Contura II

Contura III

Contura IV

Contura V

Contura VII

Contura XIV

7. ACTUATOR LENS LEGEND

00 No legend this location
 (used with codes 11-18 in box 5) Box 7 required when rocker requires two legends. If the two legends consist of one lens and one body legend, lens legend must be specified in box 5; body legend specified in box 7.
 See standard legends codes page. Consult factory for additional icons.

Continue to next page for Contura VI, X, XI & XII rocker styles.

Ordering Scheme

Part 3: Rockers (Continued)

All Rocker options must match box 4 from part 1. For additional options, consult factory.

Contura VI (WAVE)

Sample Part No. VT H Z Z C B - 00 0 00

Selection 1 2 3 4 5 6 7 8 9

1. SERIES

VT V-Series Contura VI

2. ACTUATOR STYLE

Contura VI
H High Insert  **L** Low Insert 

3, 4. LENS

Z - No Lens
 Clear White Amber Green Red Blue Lens Style
 - **7** **C** **H** **N** **U** Bar Lens Translucent 
3 - **D** **J** **P** **V** Bar Lens Transparent 
4 - **E** **K** **R** **W** Oval Lens Transparent 
 - **A** **F** **L** **S** **Y** Oval Lens Translucent 
 Lens color for LEDs must be clear, white, or match color of LED.



5. ACTUATOR COLOR

C Black **H** Gray **S** Red **Y** White







6. INSERT COLOR

B Black **S** Satin Chrome Plated
C Bright Chrome Plated **T** Satin Nickel Plated
D Satin Chrome Painted **W** White
N Bright Nickel Plated

7. ACTUATOR LENS OR BODY LEGENDS

11 ON **12** OFF **13** | **14** O 
 OFF ON O |
15 O O **16** O O **17** O | **18** | O 
 F N F N F F
 See standard legends codes page. Consult factory for additional icons.

8. LEGEND ORIENTATION

0 No legend (used with codes 11-18 in box 7)
1 Orientation 1 
2 Orientation 2 
3 Orientation 3 
4 Orientation 4   

Contura X, XI and XII



Sample Part No. VV 1 Z C 00 - 0 00

Selection 1 2 3 4 5 6 7

1. SERIES

VV V-Series Rocker

2. ACTUATOR STYLE AND COLOR

	Black	Gray	White	Red	
Contura X	1	2	3	4	
Contura XI	6	7	8	9	
Contura XII	J	K	N	M	





3, 4. LENS

3. Lens above lamp 1 terminal. 4. Lens above lamp 2 terminal.

Z - No Lens
 Clear White Amber Green Red Blue Lens Style
3 **8** **D** **J** **P** **V** Bar
4 **9** **E** **K** **R** **W** 1 piece square
5 **A** **F** **L** **S** **Y** 2 piece square*
 (clear top protective lens)
2 **7** **C** **H** **N** **U** 2 piece square*
 (smoke top protective lens)
1 **6** **B** **G** **M** **T** 2 piece square*
 (white top protective lens)





* All bottom lenses are molded of opaque material. Consult factory for other lens colors. Lens color for LEDs must be clear, white, or match color of LED.

5. ACTUATOR LENS OR BODY LEGENDS

11 ON **12** OFF **13** | **14** O 
 OFF ON O |
15 O O **16** O O **17** O | **18** | O 
 F N F N F F
21 OFF **22** ON **23** O **24** | 
 OFF ON O |
25 O **26** O **27** O **28** | 
 F N F N

See standard legends codes page. Consult factory for additional icons.

6. LEGEND ORIENTATION

0 No legend (used with codes 11-28 in box 5)
1 Orientation 1 
2 Orientation 2 
3 Orientation 3 
4 Orientation 4  

7. ACTUATOR LENS LEGEND

00 No legend this location
 (used with codes 11-18 in box 5) Box 7 required when rocker requires two legends. If the two legends consist of one lens and one body legend, lens legend must be specified in box 5; body legend specified in box 7.
 See standard legends codes page. Consult factory for additional icons.

Dimensional Specs

inches [millimeters]

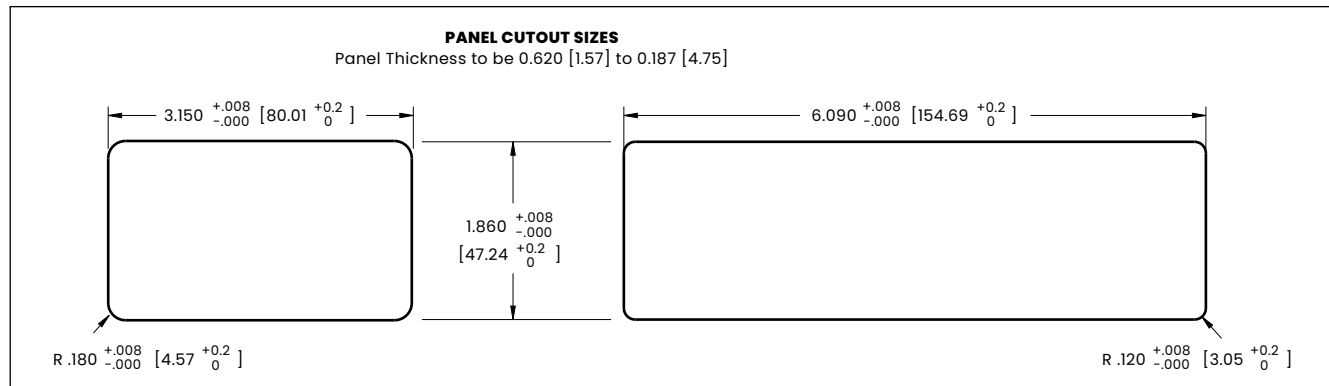
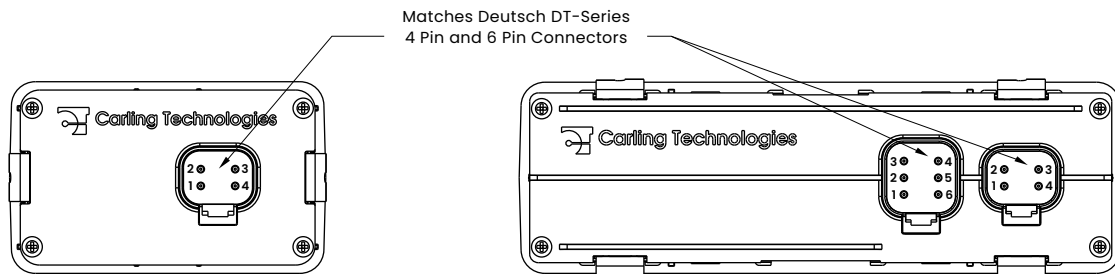
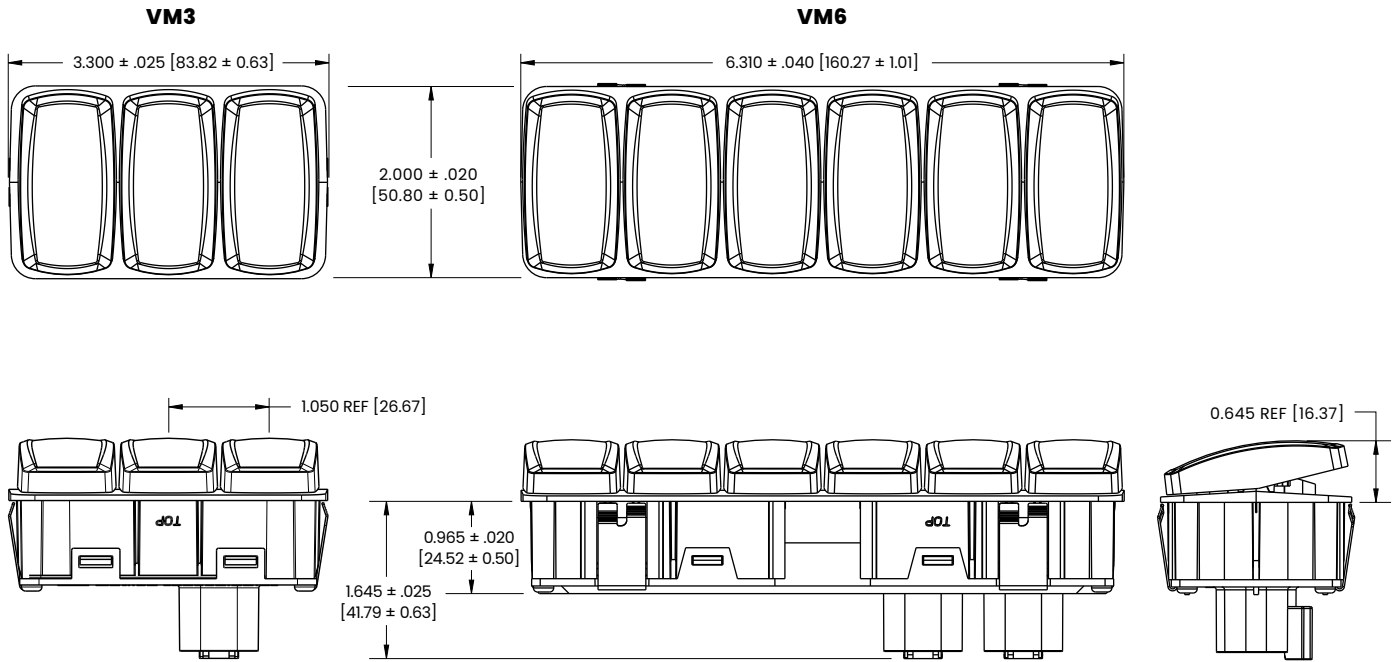

Orientation Diagram

Orientation 1

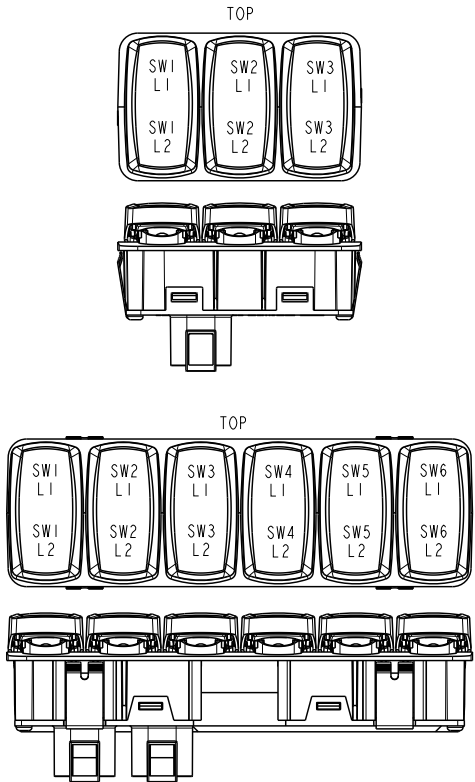

Orientation 2

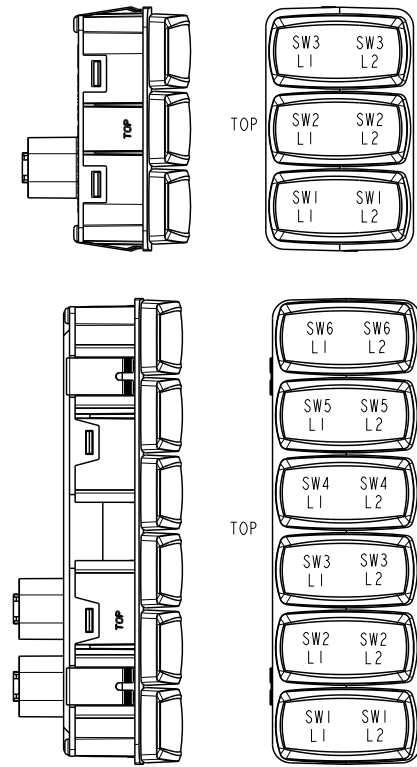

Orientation 3

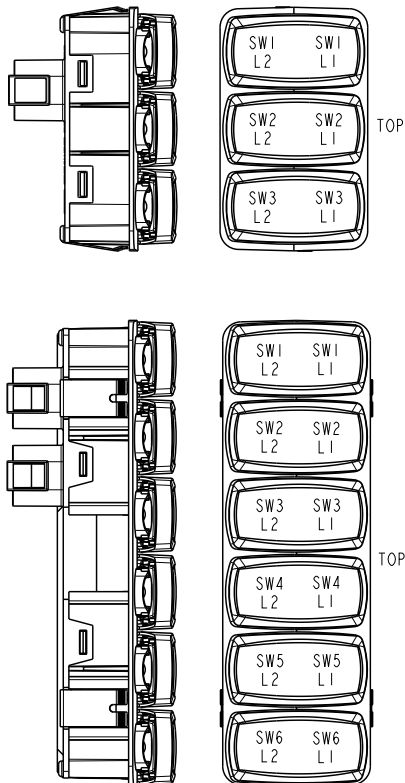

Orientation 4

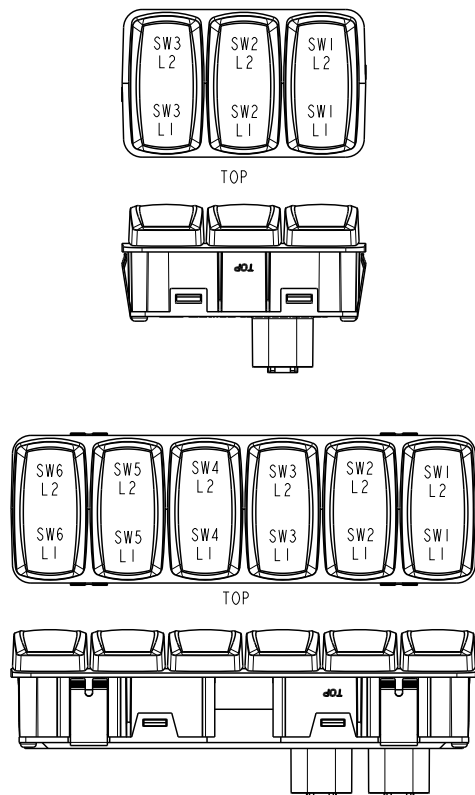

Standard Legend Codes

YK	UA	UB	US	UV	UW	UX	UY	MP	MR	PX	MS	MT
VU	MW	NZ	NX	NY	YM	VW	PS	PW	PZ	WG	WM	RN
RP	YG	TX	VD	VE	VF	VG	SH	SM	SN	SP	SR	SY
DIM	BRIGHT	UH	UJ	PD	PE	PF	VC	VJ	UF	UG	MU	TN
WY	WZ	WIPER	VZ	YE	NN	RW	PU	WA	YN	UE	NM	RJ
NS	PB	SE	VR	SL	VA	UC	VN	PK	VY	HORN	RH	NU
NR	YD	TL	VR	SL	VA	UC	VN	PK	VY	UZ	RH	NU
NV	RB	RC	RK	RL	MZ	RG	UP	DOWN	UD	UR	WD	TY
PA	UK	WATER PUMP	UU	UT	ANCHOR	PM	VV	WB	TB	TC	TD	TE
MY	PV	TA	TZ	WC	PT	PN	PH	RA	TU	TT	YL	SK
VS	UL	UM	WK	TS	VT	WL	VP	YJ	PJ	RY	UP	NW
NP	RE	RF	PP	PR	TV	PC	YT	YU	PL	WJ	MV	RR
TK	RT	SEAT	VX	WF	WH	PG	SJ	YA	YB	RM	TM	RD
RS	UN	TP	TR	NT	MX	YC	TW	TJ	YF	TH	TF	TG
YS	YH	AUX	ON OFF	OFF ON	I O	O I	OFF ON	ON	OFF	I	O	II
RAISE	LOWER	HIGH	LOW	FWD	REV	DEPTH	TRIM TAB	ACC	NAV ANCH	WIND LASS UP/DN	LIVE WELL	REAR
ST	SU	WU	WV	SV	SW	VB	VH	VK	VL	VM	WE	SF
PARK	AUTO	RU	RV	RX								
SG	SS											

Authorized Sales Representatives and Distributors

Click on a region of the map below to find your local representatives and distributors or visit www.carlingtech.com/findarep.



About Carling

Founded in 1920, Carling Technologies is a leading manufacturer of electrical and electronic switches and assemblies, circuit breakers, electronic controls, power distribution units, and multiplexed power distribution systems. With six ISO9001 and IATF16949 registered manufacturing facilities and technical sales offices worldwide, Carling Technologies Sales, Service and Engineering teams do much more than manufacture electrical components, they engineer powerful solutions! To learn more about Carling please visit www.carlingtech.com/company-profile.

To view all of Carling's environmental, quality, health & safety certifications please visit www.carlingtech.com/environmental-certifications.